

JOHN WEISS & SON, LTD.

17 WIGMORE STREET,
LONDON, W.1

Telephone: MUSeum 7733

INSTRUMENTS FOR CORNEAL SUTURING

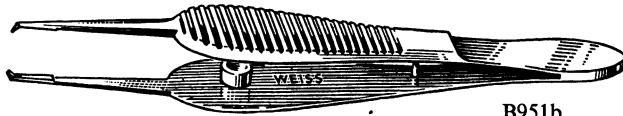

B951b

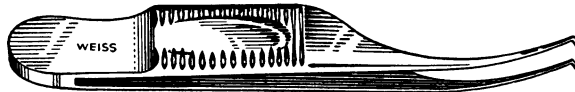

B874

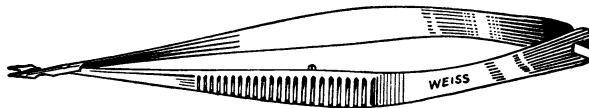

B1053

- B951b.** Suture Forceps, corneal, St. Martin's, *stainless steel*.
- B874.** Forceps, corneal, Barraquer's *do.*
- B1053.** Scissors, miniature, for removal of corneal sutures, etc.

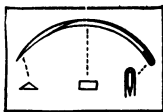

B607



B608

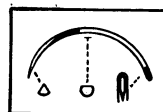

B609

- B607.** Needles corneal, Jameson Evans', 8, 10 and 14 mm.
- B608.** Ditto *do.* Kalt's, 12, 14 and 18 mm.
- B609.** Ditto *do.* Vogt's, 7, 10 and 14 mm.

You are cordially invited to visit our new Showrooms at 17, Wigmore Street, W.1, and inspect a comprehensive range of Ophthalmic Instruments and Apparatus.

CLIFFORD BROWN L^D.

45 WIGMORE STREET, LONDON, W.1

MANUFACTURING DISPENSING OPTICIANS

take pleasure in announcing the opening of a

NEW BRANCH

AT

5 SOUTH STREET

EXETER

Telephone: EXETER 77698

BRANCHES AT

EAST SHEEN, GLASGOW, KINGSTON, MANOR PARK, MORDEN,
ORPINGTON, PERTH, PUTNEY, REDHILL, REIGATE, RICHMOND,
S. WIMBLEDON, SUNDERLAND, TWICKENHAM, VICTORIA,
WANDSWORTH, WATERLOO, WELLING, WIMBLEDON, WORTHING,
WEST WORTHING

BORALINE

decongestive
mildly
antiseptic

ideal in
conjunctival
irritation



Sole distributors:

COATES & COOPER LTD. WEST DRAYTON, MIDDLESEX

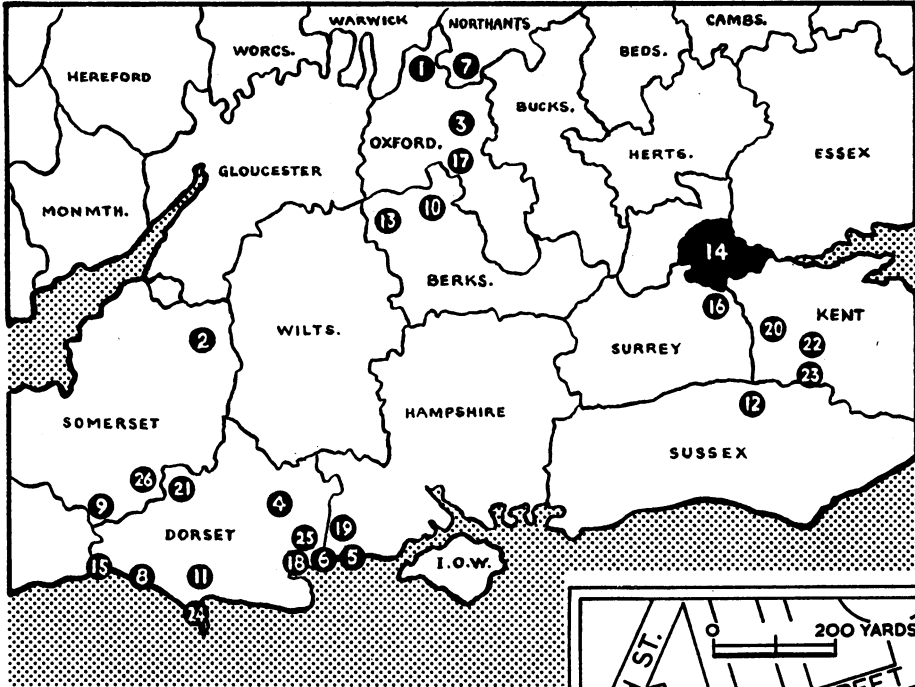

- | | |
|--------------------|---------------------|
| 1. BANBURY | 14. LONDON |
| 2. BATH | 15. LYME REGIS |
| 3. BICESTER | 16. MITCHAM |
| 4. BLANDFORD | 17. OXFORD |
| 5. BOSCOMBE | 18. POOLE |
| 6. BOURNEMOUTH | 19. RINGWOOD |
| 7. BRACKLEY | 20. SEVENOAKS |
| 8. BRIDPORT | 21. SHERBORNE |
| 9. CHARD | 22. TONBRIDGE |
| 10. DIDCOT | 23. TUNBRIDGE WELLS |
| 11. DORCHESTER | 24. WEYMOUTH |
| 12. EAST GRINSTEAD | 25. WIMBORNE |
| 13. FARINGDON | 26. YEIOVIL |

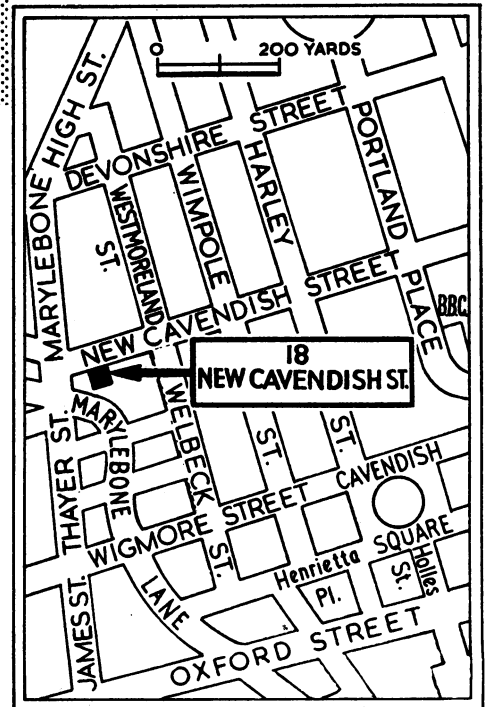

MELSON WINGATE LIMITED

“We did not want to leave Wigmore Street. We thought it was a nasty blow after so many years. How glad we are, however, that we were forced to do so. Larger, lighter, and all on one floor, our new premises have greatly pleased all who have entered therein.”

Melson Wingate Ltd

DISPENSING OPTICIANS

**18 NEW CAVENDISH STREET
LONDON W.1.**

TELEPHONE: WELbeck 8710



Hi-Lyne by Clement Clarke

Accurate dispensing . . .
individual styling

Service to the Consultant and his patient is
available through forty-three branches.

CLEMENT CLARKE LTD.

WIGMORE STREET, LONDON, W.1. Telephone: LANgham 2242



Harcourt by Clement Clarke

Accurate dispensing . . .
individual styling

Service to the Consultant and his patient is
available through forty-three branches

CLEMENT CLARKE LTD.
WIGMORE STREET, LONDON, W.1. Telephone: LANGham 2242

AN ESTABLISHED FAVOURITE

+ MORE LIGHT

+ FOCUSING
CONTROL

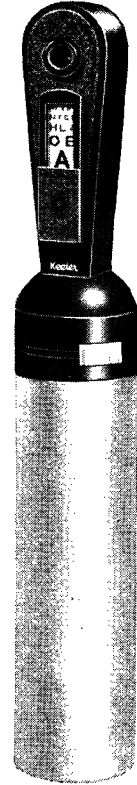

New achromatic lenses give the New Era Dynamic Retinoscope even more brightness and sharply defined reflex than the original Keeler R.T.J. model.

In addition, for maximum light and sensitivity, a focusing adjustment alters the light beam from divergence to slight convergence. For all positions of the control a plane mirror reflex is obtained.

IMPROVED RETINOSCOPY BY

	<h1>Keeler</h1>	<p>INSTRUMENTS THAT LEAD THE WORLD</p>
--	-----------------	---

39 WIGMORE STREET, LONDON, W.1.



Connoisseur Distance Type



The presentation of any one of four card-mounted distance types is electrically controlled by push-button. Chromatic Distance Test and Maddox 'Spot' are built into the base.

No. 813

EQUIPMENT FOR THE CONSULTING ROOM

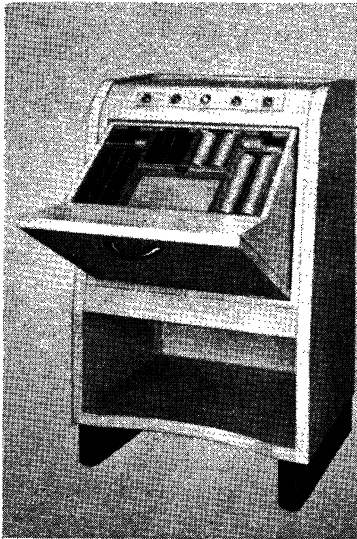

Console Trial Cabinet



Made in Hamblin's own cabinet shop and finished to individual taste. The trial lenses are completely protected in a compartment balanced for easy opening and closing and cushioned against shock. A switch panel bears controls for e.g. Hamblin's Connoisseur Distance Type, Mains Ophthalmoscope and Hand Slit Lamp, also for general room lighting.

THEODORE HAMBLIN LTD

15 Wigmore Street, London, W.1.



BY APPOINTMENT OPTICIANS TO HER LATE MAJESTY QUEEN MARY

C. W. DIXEY & SON LTD.
19 WIGMORE STREET : LONDON W.1.

TELEPHONE: LANGHAM 1713

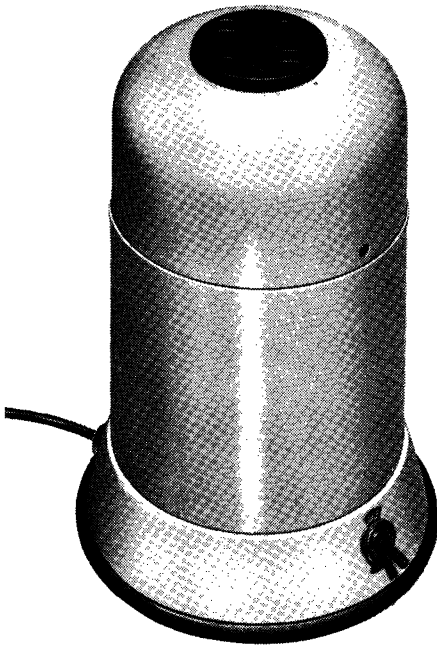

INTRODUCING
THE NEW
ULTRA VIOLET RAY
TONOMETER
STERILIZER

PRICE £21
(For use on A.C. mains only)

Sterilization is achieved by placing the barrel of the Tonometer in one of the larger orifices at the top of the sterilizer. The tonometer is thus supported whilst its base and plunger end is irradiated for approximately 40 seconds. Extensive tests have shown that this treatment destroys bacteria and viruses, including *P.s. pyocyanea*. Provision is made for treating two tonometers together, either assembled or with their plungers removed and placed in the smaller orifices.

(This sterilizer was suggested by S. S. Sumner Esq., F.R.C.S., of Preston and is made exclusively for Dixey by Hanovia Ltd.)

C. W. DIXEY & SON LTD.
19 WIGMORE STREET · LONDON W.1.

TELEPHONE: LANGHAM 1713



Introducing the NEW DIXEY ERISIPHAKE PUMP

This unit has been specially developed to give consistent and reliable operation for long periods with the minimum of attention.

It incorporates a hardened and ground stainless precision gear pump and a unique oiling system which ensures that the pump is always working under optimum conditions.

It is supplied complete in carrying case with footswitch, Barraquer Cannula-handle and rubber tubing and is suitable for operation on AC or DC mains.

We shall be pleased to supply further details on request.

*The Highest Standards of
Optical Dispensing . . .*

ALFRED

HAWES

and Son Ltd.

120 YEARS OF UNBROKEN SERVICE

The firm of Alfred Hawes was established in 1840, and is actively controlled today by descendants of the Founder.

Up-to-date techniques and this long experience enable us to offer the widest possible service, but we have never departed from the tradition of personal attention to individual requirements.

That tradition is faithfully maintained in all our branches. We look forward to dispensing the requirements of your patients.

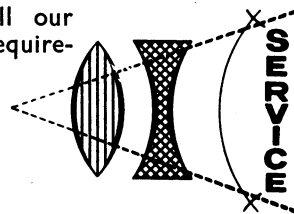

HEAD OFFICE:

79-79a, LEADENHALL STREET, LONDON, E.C.3

TELEPHONE: AVENUE 4538/9

WEST END OFFICE: 25, NEW CAVENDISH STREET, LONDON, W.1. Telephone: WELbeck 7862

BRANCHES:

BOW:	<i>Advance</i> 2103	GUILDFORD:	<i>Guildford</i> 4911	ST. PAUL'S CRAY:	<i>Foots Cray</i> 4803
CHISLEHURST:	<i>Imperial</i> 4433	ILFORD:	<i>Valentine</i> 5825	STRATFORD:	<i>Maryland</i> 3393
CROYDON:	<i>Croydon</i> 5779	LEATHERHEAD:	<i>Leatherh'd</i> 3157	WALTHAMSTOW:	<i>Coppermill</i> 5206
DORKING:	<i>Dorking</i> 3187	LEWISHAM:	<i>Lee Green</i> 2245	WOKING:	<i>Woking</i> 944
ELTHAM:	<i>Eltham</i> 4325	LEYTON:	<i>Leytonstone</i> 2109	WALTON-ON-THAMES:	
GODALMING:	<i>Godalming</i> 2088	ROMFORD:	<i>Romford</i> 42208		<i>Walton</i> 1832

OCULAR PROSTHETICS

MR. STEER WARDMAN

Artificial Eye Specialist

of

Brooks & Wardman

Dispensing Opticians

Artificial Eye Makers

Mr. Steer Wardman will be pleased to accept your referred patients for the fitting of Artificial Eyes and Cosmetic Contact lenses by appointment at:—

24 REGENT STREET — NOTTINGHAM
Telephone: 46309 (2 lines)

91 CORNWALL STREET — BIRMINGHAM
Telephone: Central 0583

28 WATSON ROAD — WORKSOP
Telephone: 3204

J. W. WARDMAN LTD.

54 DUKE STREET — DARLINGTON
Telephone: 66089

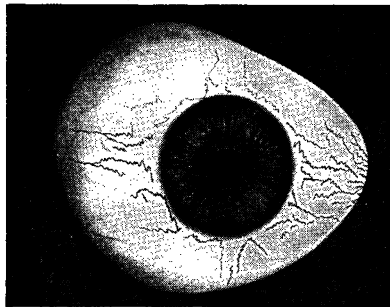

My work covers all recent advances in ocular prostheses, magnetic artificial eyes, and facial prostheses.

Rayner

TRIAL CASES

We invite you to inspect our range

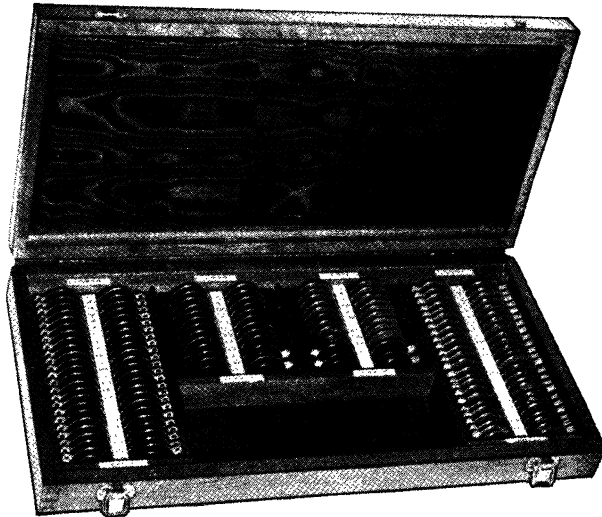

BRITISH STANDARD 3162/1959
All lenses and mounts in Rayner Trial Cases
comply with this British Standard

INSTRUMENT DEPARTMENT:

160 New Bond Street, London, W.1.

MAYfair 0128

BEXHILL, BIRKENHEAD, BOLTON, BRADFORD, BRIGHTON, BRIXTON, CHESTER, COVENTRY,
CREWE, DONCASTER, EASTBOURNE, ELLESMERE PORT, HALIFAX, HARROGATE, HASTINGS,
HEREFORD, HESWALL, HOVE, HUDDERSFIELD, HULL, LEAMINGTON, LEEDS, LEICESTER,
LIVERPOOL, LUDLOW, NORTHWICH, NUNEATON, OLDHAM, OSWESTRY, RHYL, RUGBY,
RUGELEY, SHREWSBURY, SOUTHPORT, STAFFORD, ST. HELENS, STOKE, STREATHAM,
WALLASEY, W. HARTLEPOOL, WORCESTER. Works: HOVE and LONDON.

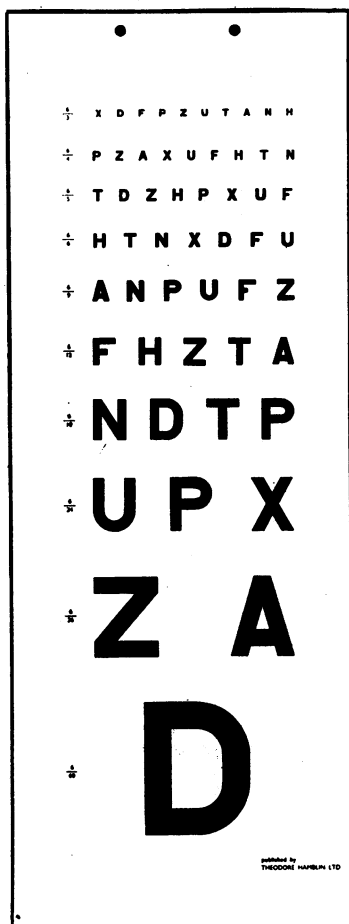

The LAW Distance Type

(Designed at the suggestion of
Mr. Frank Law)

Patients almost invariably read a distance type throughout, starting at the top and ending at the limits of their visual acuity. In the Law Distance Type, the sequence of standards is reversed, beginning with 6/3 and ending with 6/60. A patient is thus impelled to call the smallest letters he can see at the outset, so saving the ophthalmologist's time.

THEODORE HAMBLIN LTD

15 Wigmore Street, London, W.1.

FOR
REDUCTION
OF
INTRA-OCULAR
PRESSURE
IN
GLAUCOMA

the new
potent
carbonic anhydrase
inhibitor

DARANIDE Regd

Dichlorphenamide. Tablets of 50 mg.

Dosage range: $\frac{1}{2}$ -1 tablet,
once to four times daily.

*United Kingdom N.H.S. basic cost
of 12 tablets: 4s. 9½d.*



MERCK SHARP & DOHME LIMITED, HODDESDON, HERTS

the
**CARL
 ZEISS**
 slit
 lamp

is now
 available
 for
 immediate
 delivery
 from stock

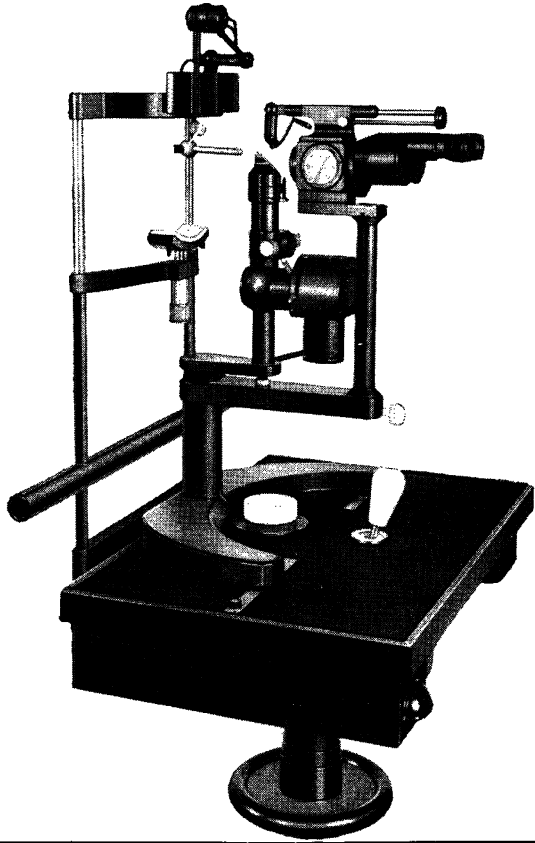

RENOWNED FOR ITS BRILLIANT ILLUMINATION,

the Carl Zeiss Slit Lamp has
 the following additional advantages:

- * Rapid change between five different magnifications
- * Great depth of focus
- * Particularly sturdy design gives years of hard service
- * Easily equipped with full range of accessories:
 - [1] Camera equipment. [2] Hruby lens
 - [3] Tutor eyepiece. [4] Gonioscopy equipment
 - [5] Aplanation Tonometer

Illustrated booklet on request from

Degenhardt
 AND COMPANY LIMITED

6 Cavendish Square, London W1 Telephone LANgham 6097

★ THE
GAMBS SLIT LAMP
 BIOMICROSCOPE

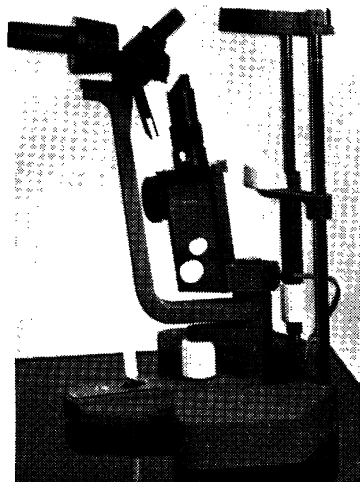

The EXCEPTIONAL ILLUMINATION in the Gambs Slit-lamp is adequate for DIRECT COLOUR PHOTOGRAPHY of the anterior segment, lower intensity is always available by turning a three-position switch.

A simple and inexpensive attachment enables the microscope to be replaced by a single lens reflex camera of the interchangeable lens type; the exchange is simple and takes no more than a few moments.

In order to take full advantage of such illumination particular care has been taken in designing the microscope, reflecting surfaces have been minimised in order to preserve MAXIMAL CONTRAST in the observed image.

Thirty three years specialized experience in the design and production of slit-lamps have impressed upon us the value of such attention to detail

 Please write for fully descriptive literature

**SLIT LAMP
 OPHTHALMOMETER
 PERIMETER
 TRANSLATING TABLES
 ADJUSTABLE STOOLS**



INDIA — HANS RAJ NAYYAR & CO.
 AMRITSAR
 AGENTS: UNITED KINGDOM — STERCKS MARTIN LTD.
 LONDON W.1

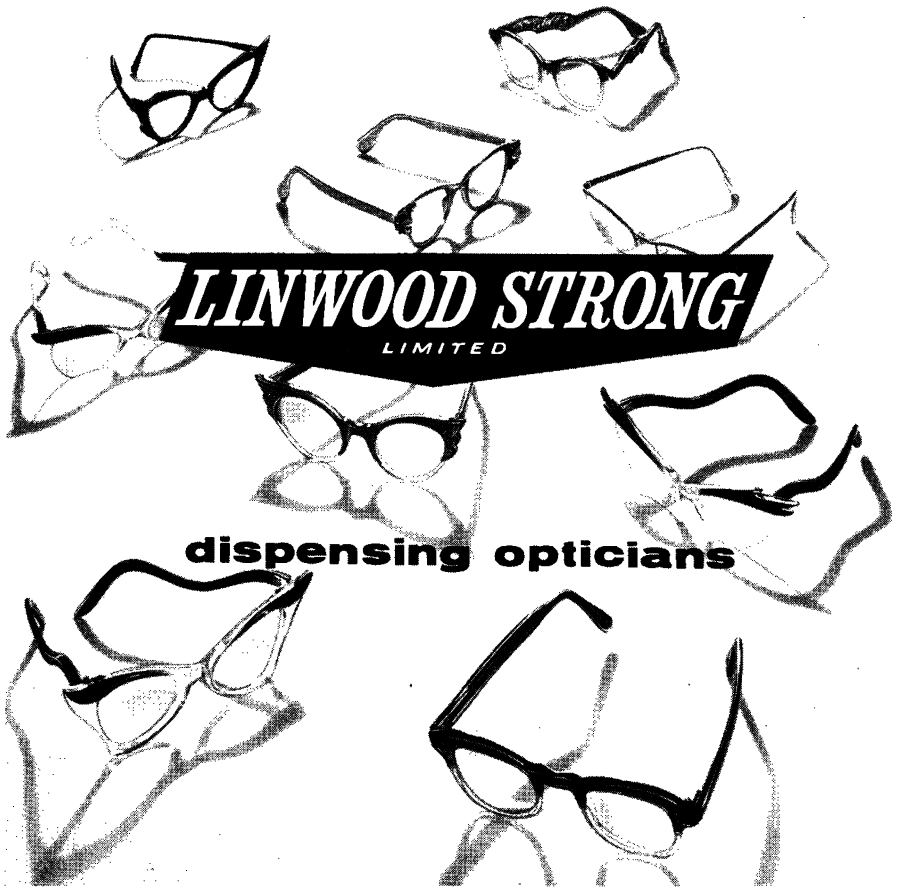

20 High Street,
Sutton, Surrey.
Telephone: VIGilant 2798.

45 Upper High Street.
Epsom, Surrey.
Telephone: EPSom 2300.

Chapel Road,
Worthing.
Telephone: Worthing 5193.

57b London Road,
Brighton.
Telephone: Brighton 29425.



THE ROPER-HALL FOREIGN BODY LOCATOR

DETECTS metallic foreign bodies, whether ferrous or non-ferrous. At maximum sensitivity it will detect a 1 mm. particle of steel at 30 mm. ($1\frac{1}{4}$ "), or a needle fragment at 10 cms. (4").

DISCRIMINATES between magnetic and non-magnetic metals. This information is given both visually, by needle deflection on the meter, and audibly, through an amplifying device. Ferrous particles give a meter deflection to the left, with a low note; non-ferrous bodies give a deflection to the right and a high note.

LOCALISES by indicating the precise position, when using the 'Spatula' probe, to within ± 0.3 mm. A 3-position switch ensures appropriate sensitivity to suit the size of particle or depth of penetration.

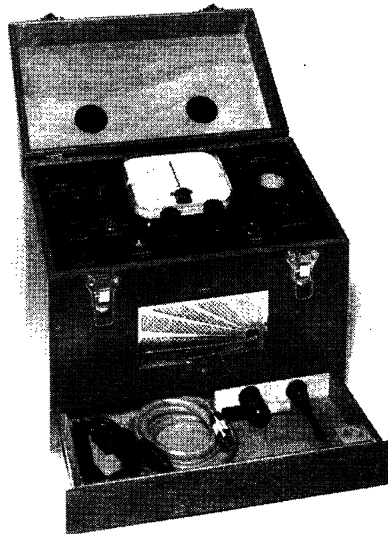

OTHER FEATURES

- ★ Ready for use within 30 seconds of switching on.
- ★ Electrical "balance" is quick and simple to achieve.
- ★ Rechargeable battery ensures complete portability and it is therefore unaffected by mains voltage fluctuations.



39 WIGMORE ST.,
LONDON, W.1

Fashion Frames

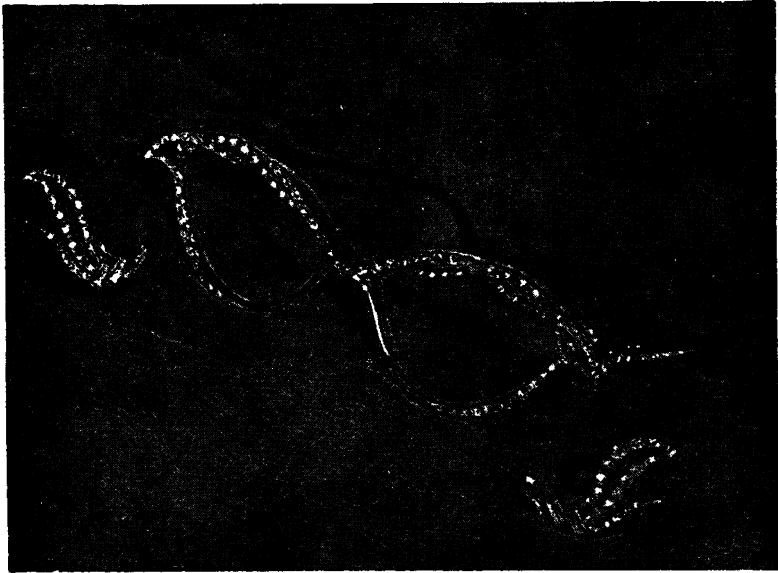

* *

*A further example of the spectacle-maker's craft,
combined with the jeweller's. Hand-made frames,
trimmed hand-set rhinestones and pearls.*

Earrings to match.

* *

Made and Designed by

A. E. NEWBOLD, LTD

11b, Hay Hill, Berkeley Square, London, W.1

HYDE PARK 094616

Branch: 1 Broadway Buildings
BROMLEY, Kent

Branch: 64 High Street
BECKENHAM, Kent

*

. . . to determine
corneal thickness

Designed and individually
calibrated in the laboratories
of the Institute of Ophthalmology

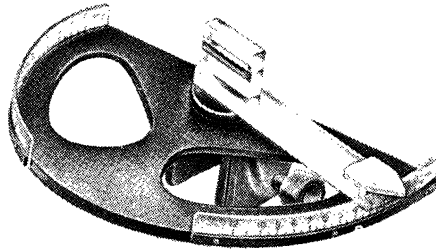

*An accessory for use with the
Haag-Streit (Goldmann) Slit-lamp*

THE STERCKS MARTIN

**CORNEAL
PACHOMETER**

Please write for
full particulars to the
exclusive producers

Stercks Martin
LTD

INSTRUMENT DEPARTMENT - 36 NEW CAVENDISH ST., W.1

OPHTHALMIC DIATHERMY

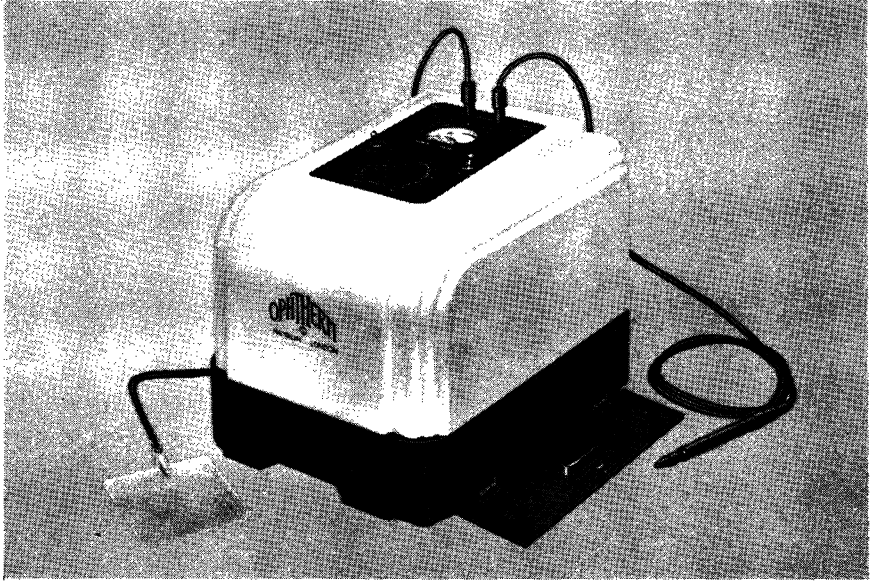

Hamblin "OPHTHERM"

*a choice of two models
with output of identical frequency*

**Valve or
Spark Gap**

Simple, safe and dependable, the Hamblin OPTHHERM is a diathermy designed especially for ophthalmic surgery. Proved extremely stable and efficient, it has an output adequate for every type of patient and every degree of tissue resistance. Output, shown on a milliammeter, is controlled by either hand- or foot-switch. A graduated scale enables any setting to be repeated with exactitude; a tick at one-second intervals facilitates the timing of treatment. The OPTHHERM is compact and easily portable, and its robust case completely protects the circuitry.

THEODORE HAMBLIN LTD

15 Wigmore Street, London, W.1.

Distance Types by HAMBLIN

15 Wigmore Street, London, W.1.

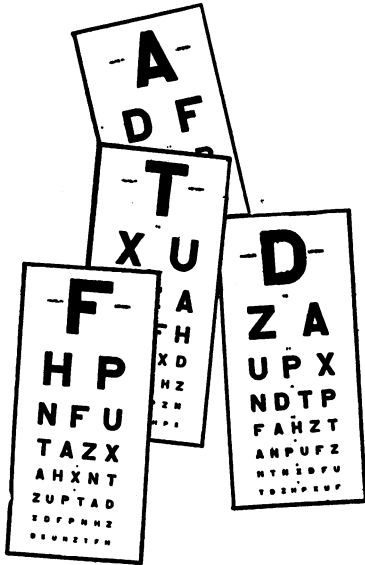

For Three Metres

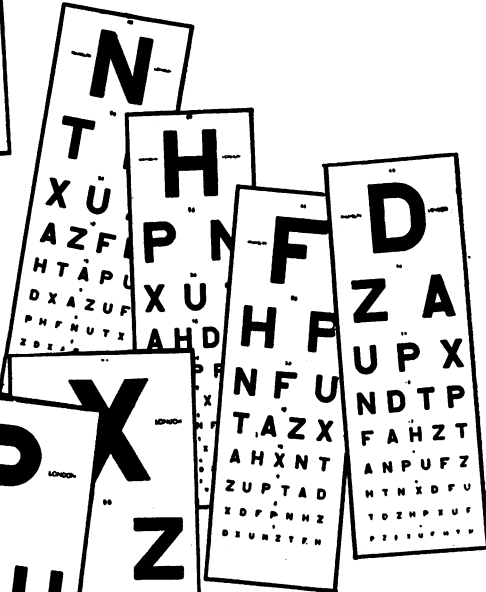

For Five Metres

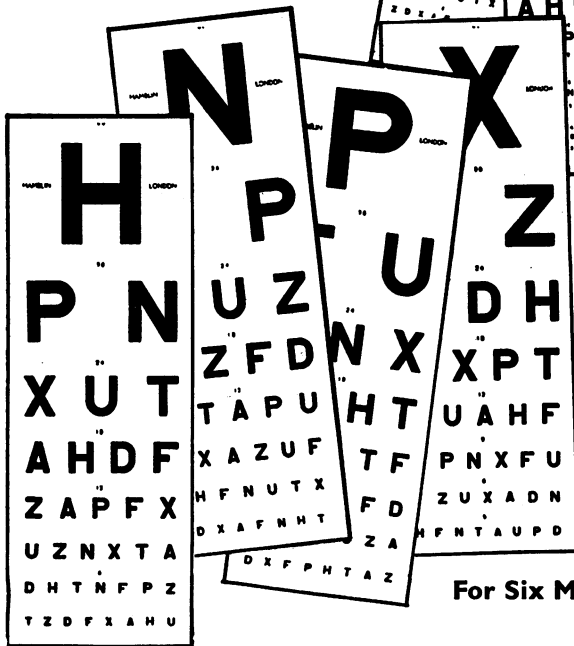

For Six Metres

The HAAG-STREIT Slit Lamp '900'

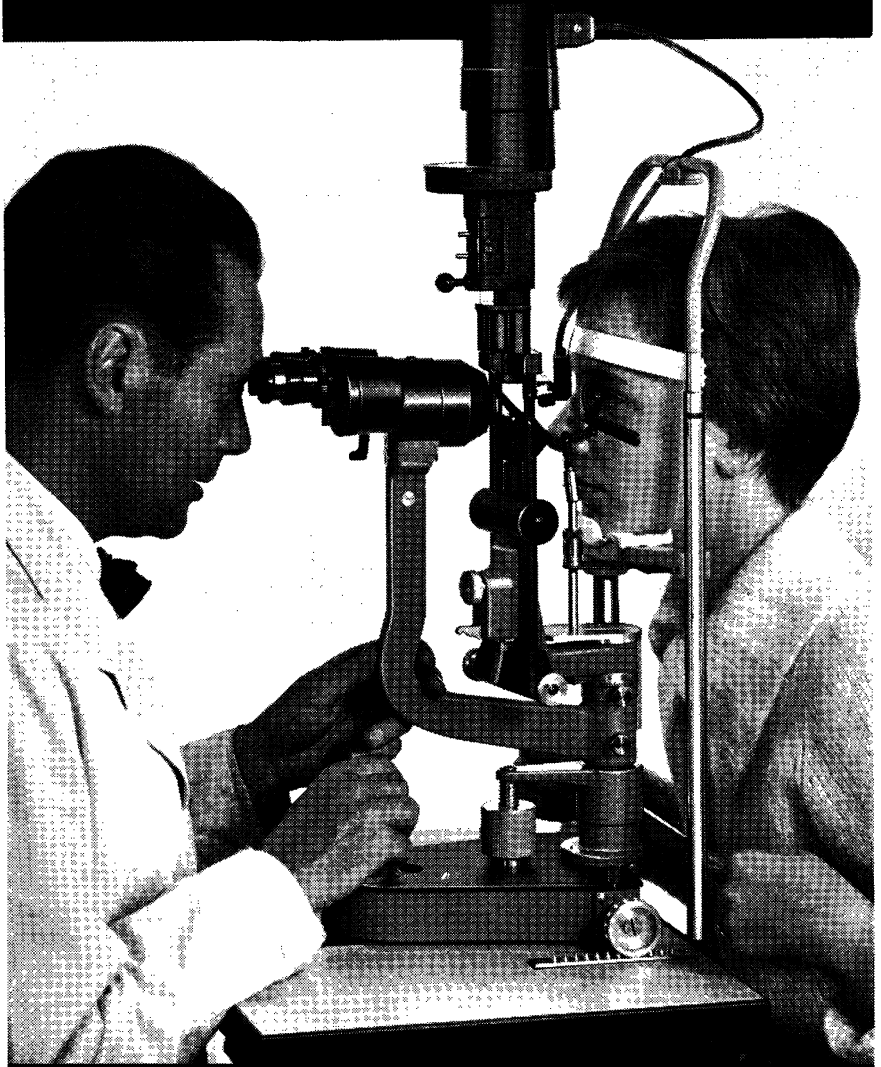

CLEMENT CLARKE LTD.

The HAAG-STREIT Slit Lamp '900'

The HAAG-STREIT Slit Lamp '900'
represents a very exceptional advance in design, the
result of years of intensive research.

STAR FEATURES

- * Precentred and prefocused bulb, burning cap uppermost.
Illumination 30% above previous model.
- * Overload switch nearly doubles illumination.
- * Slit rotates through 180°. No deviating prism used.
- * Unique inclining device provides horizontal *sections*.
- * Hruby Lens preset and linked to microscope.
- * Non-dazzling fixation target focused at far point.
- * Aplanation Tonometer attached and removed at will.
- * New Fundus Lens for high myopes available.
- * Measuring device available.

Clement Clarke are the
sole agents in the United Kingdom
for Haag-Streit

Please note that the
Ophthalmic Instrument Division
has moved to new showrooms at
16, WIGMORE STREET, LONDON, W.1

Instrument Division, Wigmore St., London, W.1.

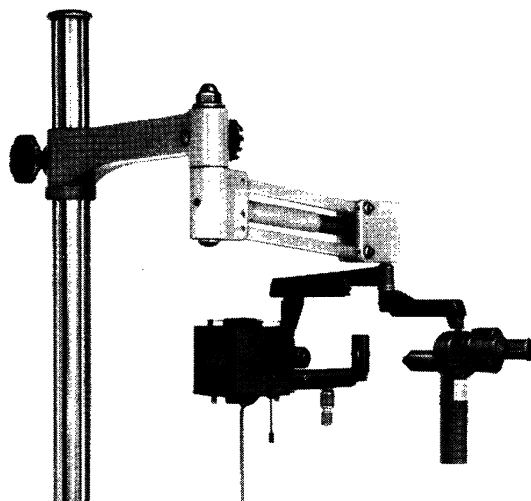

*This is
the
NEW
BRITISH*

Curpax SLIT LAMP

BASIC SLIT LAMP & MICROSCOPE UNIT £150

The portable
model illustrated here
was designed
by us for
Professor Ida Mann
to aid her
Trachoma research.

It is available
in a number of
other combinations.

Made by the
Instrument Division of **CURRY & PAXTON LTD**

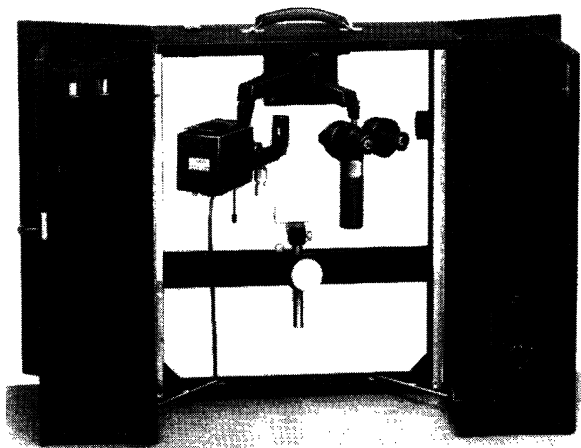

**The Stereoscopic
Microscope
is readily
detachable for
RECUMBENT
GONIOSCOPY**

The BASIC UNIT
may be fitted

- To a counterpoise arm
- On Refractor Stand
- On wall bracket
- On a table model
- In a portable box
- A.U.V. fitter is available
for contact lens work

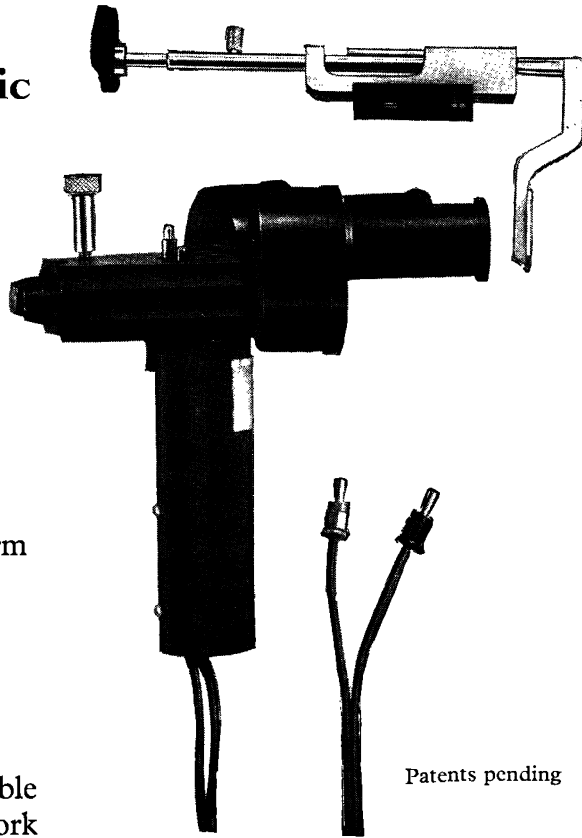

Patents pending

**Really BRILLIANT SLIT ILLUMINATION
and CONTRAST**

May be used with the patient seated in Ophthalmic chair without chinrest. There is no obstruction of the patient and he cannot draw away from the beam.

CURRY & PAXTON, LTD

Dispensing Opticians, Manufacturers of Ophthalmic Instruments

195-199, GREAT PORTLAND STREET,
LONDON, W.1.

Telephone: LAngham 0123

INSTRUMENT DEPARTMENT,
129, ALBERT STREET, PARKWAY, N.W.1.

Telephone: GULLiver 7939

PRINCIPAL BRANCHES — BATH, BRISTOL, CHIPPENHAM, CHISWICK, DERBY, GLASGOW,
LINCOLN, LOWESTOFT, NEW CROSS, NEWARK, NORWICH, NOTTINGHAM, RICHMOND, SCUNTHORPE,
SHEPHERDS BUSH, SOUTHPORT, WARRINGTON, WESTON-SUPER-MARE, WOOLWICH.

W. CALLAGHAN & S. P. HOLLOWAY LTD.

ACCURATE & PROMPT DISPENSING

PERSONAL ATTENTION BY
THE PRINCIPALS

14_A, HENRIETTA PLACE

(Corner of Welbeck Street)

LONDON · W.1

Telephone Welbeck 2703

GEORGE ODELL LTD.

DISPENSING OPTICIANS

A. H. ODELL, *Managing Director.*

M. ODELL, *Secretary.*

Members of the Guild of

British Dispensing Opticians

Makers of spectacles of a fine precision and of a standard worthy of the best work of British craftsmen—a very important but fast-dwindling section of the optical industry.

Frames are made and mounted to the individual measurements of each patient and both frame and lenses periodically checked during the course of production.

The finished spectacles are finally checked by a qualified dispensing optician and whenever possible, personally fitted on every patient.

**31, KING STREET,
ST. JAMES'S, S.W.1**
Whitehall 9987

**36, WELBECK STREET
W.1**
Welbeck 5320

NEW ITEMS

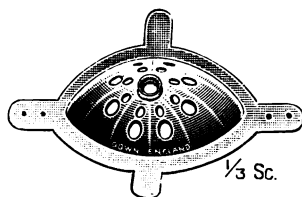

Barraquer's Eye Shield, plastic
for after Keratoplasty

DOWN BROS. and MAYER & PHELPS Ltd.

CHURCH PATH,
MITCHAM, SURREY

32-34, NEW CAVENDISH STREET,
LONDON, W.1

70, GRENVILLE STREET,
TORONTO CANADA

Faithfully yours

PANKHURST & BARRETT LTD.

Dispensing Opticians

27, NEW CAVENDISH STREET, LONDON, W.1

250, IMPERIAL DRIVE, RAYNERS LANE, HARROW

UNIVERSITY OF LONDON

INSTITUTE OF OPHTHALMOLOGY, JUDD STREET, LONDON, W.C.1Associated with
MOORFIELDS EYE HOSPITAL

Qualified Medical Practitioners may enter the practice of the Moorfields Eye Hospital at any time, and are, on certain conditions, eligible for appointment as Clinical Assistants.

Systematic courses suitable for Diploma and Degree examinations begin in OCTOBER and MARCH of each year.*For further particulars apply to the Dean.*

EXAMINATION OF PATHOLOGICAL OPHTHALMIC SPECIMENS.

The Department of Pathology of this Institute will examine and report on certain specimens sent by Ophthalmic Surgeons. Specimens sent from Hospitals for further examination should be sent through the particular Hospital Pathologist.

For particulars apply to the Director of the Department of Pathology.

ROYAL EYE HOSPITAL**ST. GEORGE'S CIRCUS, S.E.1**

Telephone: WATERLOO 4477

The clinical practice of the Hospital is open to postgraduate students. There are over 1,450 admissions annually and large daily out-patient clinics.

Courses of advanced tuition are held for the hospital medical staff; other suitable students are admitted as numbers permit.

AN AID TO LOW VISUAL ACUITY**WRAY PANORA**

LONDON

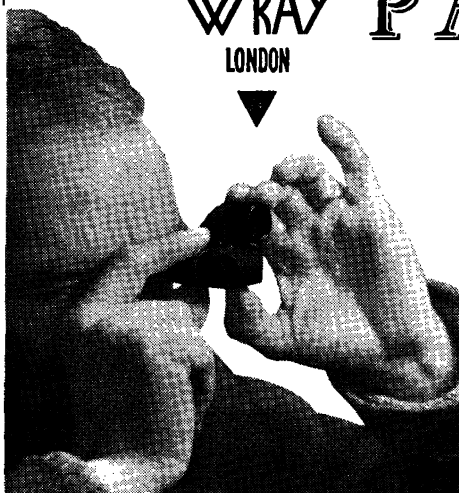

Can be supplied under the National Health Service if prescribed as clinically necessary by an ophthalmologist in the National Eye Service.

Magnification $\times 8$.

Object Glass 21 mm.

Folds flat into soft leather case
 $2\frac{3}{4}'' \times 1\frac{7}{8}'' \times \frac{3}{4}''$.*Details from***WRAY (OPTICAL WORKS) LTD****BROMLEY, KENT**

Telephone RAV 0112

A PRODUCT OF ARMOUR RESEARCH

ZONULOLYSIS

*Eliminating accident risk
in Cataract Surgery*

The inherent complications of extracapsular extraction and the accidents which sometimes occur during or after intracapsular extraction are eliminated by Barraquer's technique.

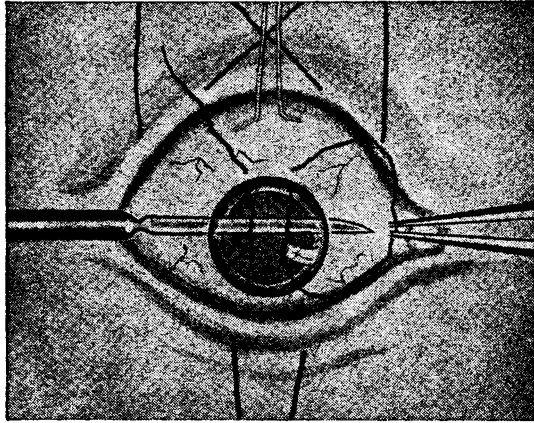

CHYMAR-ZON

brand of α -chymotrypsin

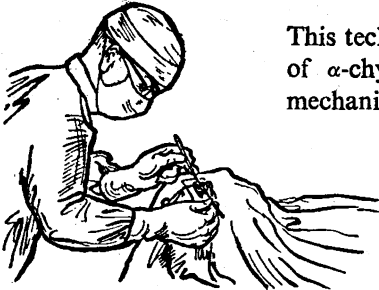

This technique employs the zonulolytic action of α -chymotrypsin, effectively replacing the mechanical procedures of zonulotomy.

PRESENTATION - each carton contains :

- 1 vial - 100 Armour units lyophilised α -chymotrypsin.
- 1 vial - 1 ml. Ringer's Solution as diluent.
- 1 vial - 1 ml. Ringer's Solution for irrigation.

Literature on request



**ARMOUR PHARMACEUTICAL
COMPANY LTD**
EASTBOURNE · SUSSEX · ENGLAND

Selection

From some of the
World's Finest Spectacleware



Neatness and allure from Germany



... dispensed
with the inherited
skill of 86 years'
experience ...

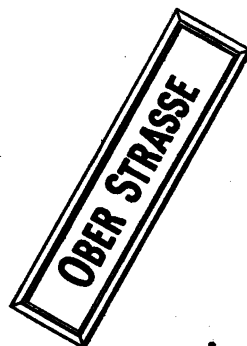

... plus
attention
that is really
personal ...

... at

SPILLERS

GEORGE SPILLER,

Ltd.

41, WIGMORE ST., W.1

Tele.: WEL. 7471-2

Also at: **57, New Kings Road, Fulham, S.W.6.** Tele: REN 6995
457A, Finchley Road, N.W.3. Tele: HAM 5524

THE FIRST OPTICIAN
IN WIGMORE STREET.
ESTABLISHED 1873